

# Data Sheet



Article number: 5861810606

Description: Flow Control Valve 181.0606, Ø6 Ø6  
Push-in

## Measures

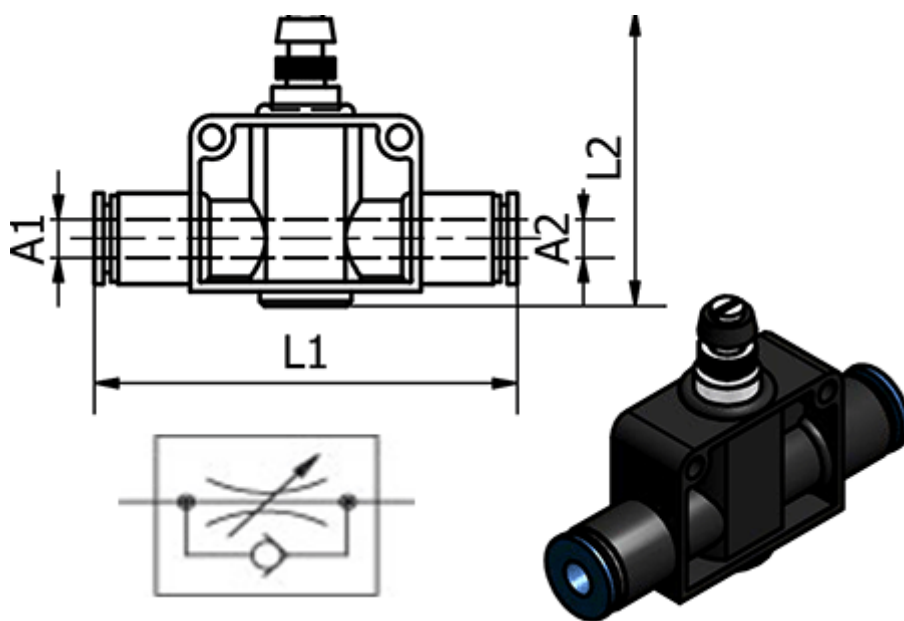

Ext. Hose Diameter A1 = 6

Ext. Hose Diameter A2 = 6

L1 = 47.6

L2 = 41.9